

**FOR CAR USE ONLY/ POUR APPLICATION AUTOMOBILE UNIQUEMENT/ NUR FÜR
AUTOMOBIL GEBRAUCH/ PARA USO EN AUTOMÓVILES/ SOLO PER L'UTILIZZO IN
AUTOMOBILE/ ТОЛЬКО ДЛЯ ИСПОЛЬЗОВАНИЯ В АВТОМОБИЛЯХ**



Advanced Dash Cam

DVR-C320R

DVR-C320S

RCV-C320

• **OWNER'S MANUAL**

Please read before using this equipment.

• **MODE D'EMPLOI**

Veillez lire avant d'utiliser cet appareil.

• **BEDIENUNGSANLEITUNG**

Lesen Sie diese Bedienungsanleitung bitte vor
Gebrauch des Gerätes.

• **MANUAL DE OPERACIÓN**

Léalo antes de utilizar este equipo.

• **ISTRUZIONI PER L'USO**

Si prega di leggere prima di utilizzare il attrezzatura.

• **РУКОВОДСТВО ПО ЭКСПЛУАТАЦИИ**

Прочтите настоящее руководство перед началом
использования оборудования.

FCC Statement

This device complies with Part 15 of the FCC Rules. Operation is subject to the following two conditions: (1) this device may not cause harmful interference, and (2) this device must accept any interference received, including interference that may cause undesired operation.

This equipment has been tested and found to comply with the limits for a Class B digital device, pursuant to Part 15 of the FCC Rules. These limits are designed to provide reasonable protection against harmful interference in a residential installation. This equipment generates, uses and can radiate radio frequency energy and, if not installed and used in accordance with the instructions, may cause harmful interference to radio communications. However, there is no guarantee that interference will not occur in a particular installation. If this equipment does cause harmful interference to radio or television reception, which can be determined by turning the equipment off and on, the user is encouraged to try to correct the interference by one or more of the following measures:

- Reorient or relocate the receiving antenna.
- Increase the separation between the equipment and receiver.
- Connect the equipment to an outlet on a circuit different from that to which the receiver is connected.
- Consult the dealer or an experienced radio/TV technician for help.
- This appliance and its antenna must not be co-located or operation in conjunction with any other antenna or transmitter.
- A minimum separation distance of 20cm must be maintained between the antenna and the person for this appliance to satisfy the RF exposure requirements.

FCC CAUTION: Any changes or modifications to the equipment not expressly approved by the party responsible for compliance could void your authority to operate the equipment.

FCC ID: 2ADTG-DVRC320R

Information to user : RSS-247

This equipment complies with IC radiation exposure limits set forth for an uncontrolled environment. This equipment should be installed and operated with minimum distance 20 cm between the radiator & your body.

This device contains licence-exempt transmitter(s)/receiver(s) that comply with Innovation, Science and Economic Development Canada's licence-exempt RSS(s).

Please be cautioned the changes or modifications not expressly approved by the party responsible for compliance could void the user's authority to operate the equipment.

Notice: Operation is subject to the following two conditions : (1) this device may not cause interference, and (2) this device must accept any interference, including interference that may cause undesired operation of the device.

This Class B digital apparatus complies with Canadian ICES-003.

IC: 12594A-DVRC320R

Contents

Operating Instructions	4	4. Operating on the Alpine navigation/ display audio system	24
1. Product overview	8	4.1 Screen layout	24
1.1 Included items	8	4.1.1 Live view screen	24
1.1.1 DVR-C320R (2 camera, USA/Canada only)	8	4.1.2 Home screen	25
1.1.2 DVR-C320S (1 camera)	9	4.2 Playing videos	26
1.1.3 RVC-C320 (Rear view only)	9	4.2.1 Playing on the Alpine navigation/display audio system	26
1.2 Part names	10	4.3 Managing the memory card	28
1.2.1 Front camera (main unit) - front view	10	5. Settings	29
1.2.2 Front camera (main unit) - rear view	11	5.1 Setting the Camera	29
1.2.3 Rear camera (RVC-C320)	11	5.2 Setting recording features	30
1.3 Removing and inserting the memory card	12	5.3 Setting road safety features	31
1.4 Basic connection diagrams	13	5.4 Configuring the system settings	32
1.4.1 Connecting the product	13	5.5 Viewing product information	33
1.4.2 Connecting the dash cam to the Alpine navigation/display audio system	14	5.6 Initializing the system settings (Reset Settings)	33
1.4.3 Setting the auxiliary (AUX) name of the navigation/display audio system	15	6. Using the mobile viewer	34
1.4.4 ADAS warning message	15	6.1 Connect the product to a smartphone	34
2. Installing the product	16	6.2 Viewing the mobile viewer screen layout	34
2.1 Installing the front camera (main unit)	16	7. Using the PC viewer	35
2.1.1 Selecting an installation location	16	7.1 System requirements	35
2.1.2 Securing the product	16	7.2 Learning about the PC viewer	35
2.2 Installing the rear camera	17	7.2.1 Installing the PC viewer	35
2.2.1 Selecting an installation location	17	7.2.2 PC viewer screen layout (for Windows)	36
2.2.2 Securing the rear camera	18	7.2.3 Playing recorded videos on the PC viewer (for Windows)	37
2.2.3 Connecting the rear camera cable	19	7.2.4 PC viewer screen layout (for Mac)	38
3. Using recording features	20	7.2.5 Playing recorded videos on the PC viewer (for Mac)	39
3.1 Turning the product on or off	20	8. Upgrading the firmware	40
3.2 Learning about file storage locations	20	9. Troubleshooting	41
3.3 Using the continuous recording feature	21	10. Specifications	42
3.4 Recording manually	21		
3.5 Using parking mode	22		
3.6 Using the Super Night Vision	23		
3.7 Using the road safety features	23		

Operating Instructions

Points to Observe for Safe Usage

Read this manual carefully before using the system components. They contain instructions on how to use this product in a safe and effective manner. Alpine cannot be responsible for problems resulting from failure to observe the instructions in this manual.

This manual uses various pictorial displays to show you how to use this product safely and to alert you to potential dangers resulting from improper connections and operation. Following are the meanings of these pictorial displays. It is important to fully understand the meanings of these pictorial displays in order to use this manual and the system properly.

Safety symbols in this guide



"Warning" - This symbol means Important Instructions. Failure to heed them can result in serious injury or death.



"Caution" - This symbol means Important Instructions. Failure to heed them can result in Injury or material property damage.



"Note" - This symbol means useful information that helps users better utilize the product's features.

Safety information for proper use

Driving and product operation



- **MINIMIZE DISPLAY VIEWING WHILE DRIVING.** Viewing the display may distract the driver from looking ahead of the vehicle and cause an accident.
- **OPERATION OF THE SYSTEM WHILE DRIVING IS DANGEROUS.** Users should stop vehicle before operating the software.
- **THIS SOFTWARE IS DESIGNED FOR USE EXCLUSIVELY IN THE UNIT.** It cannot and may not be used in conjunction with other hardware.

Power supply and product installation



- **DO NOT WATCH VIDEO WHILE DRIVING.** Watching the video may distract the driver from looking ahead of the vehicle and cause an accident.
- **DO NOT DISASSEMBLE OR ALTER.** Doing so may result in an accident, fire or electric shock.
- **USE ONLY IN CARS WITH A 12 VOLT NEGATIVE GROUND.** (Check with your dealer if you are not sure.) Failure to do so may result in fire, etc.
- **USE THE CORRECT AMPERE RATING WHEN REPLACING FUSES.** Failure to do so may result in fire or electric shock.
- **DO NOT BLOCK VENTS OR RADIATOR PANELS.** Doing so may cause heat to build up inside and may result in fire.
- **USE THIS PRODUCT FOR MOBILE 12V APPLICATIONS.** Use for other than its designed application may result in fire, electric shock or other injury.
- **MAKE THE CORRECT CONNECTIONS.** Failure to make the proper connections may result in fire, battery drain, or product damage.
- **BEFORE WIRING, DISCONNECT THE CABLE FROM THE NEGATIVE BATTERY TERMINAL.** Failure to do so may result in electric shock or injury due to electrical shorts.
- **DO NOT ALLOW CABLES TO BECOME ENTANGLED IN SURROUNDING OBJECTS.** Arrange wiring and cables in compliance with the manual to prevent obstructions when driving. Cables or wiring that obstruct or hang up on places such as the steering wheel, gear lever, brake pedals, etc. can be extremely hazardous.
- **DO NOT SPLICE INTO ELECTRICAL CABLES.** Never cut away cable insulation to supply power to other equipment. Doing so will exceed the current carrying capacity of the wire and result in fire or electric shock.
- **DO NOT DAMAGE PIPE OR WIRING WHEN DRILLING HOLES.** When drilling holes in the chassis for installation, take precautions so as not to contact, damage or obstruct pipes, fuel lines, tanks or electrical wiring. Failure to take such precautions may result in fire.
- **DO NOT USE BOLTS OR NUTS IN THE BRAKE OR STEERING SYSTEMS TO MAKE GROUND CONNECTIONS.** Bolts or nuts used for the brake or steering systems (or any other safety-related system), or tanks should NEVER be used for installations or ground connections. Using such parts could disable control of the vehicle and cause fire etc.
- **DO NOT INSTALL IN LOCATIONS WHICH MIGHT HINDER VEHICLE OPERATION, SUCH AS THE STEERING WHEEL OR SHIFT LEVER.** Doing so may obstruct forward vision or hamper movement etc. and results in serious accident.
- **DO NOT OPERATE ANY FUNCTION THAT TAKES YOUR ATTENTION AWAY FROM SAFELY DRIVING YOUR VEHICLE.** Any function that requires your prolonged attention should only be performed after coming to a complete stop. Always stop the vehicle in a safe location before performing these functions. Failure to do so may result in an accident.

Children



- **KEEP SMALL OBJECTS SUCH AS SCREWS OUT OF THE REACH OF CHILDREN.** Swallowing them may result in serious injury. If swallowed, consult a physician immediately.

Other information about the product

Product management and operation



- **HALT USE IMMEDIATELY IF A PROBLEM APPEARS.** Failure to do so may cause personal injury or damage to the product. Return it to your authorized Alpine dealer or the nearest Alpine Service Center for repairing.
- **HAVE THE WIRING AND INSTALLATION DONE BY EXPERTS.** The wiring and installation of this unit requires special technical skill and experience. To ensure safety, always contact the dealer where you purchased this product to have the work done.
- **USE SPECIFIED ACCESSORY PARTS AND INSTALL THEM SECURELY.** Be sure to use only the specified accessory parts. Use of other than designated parts may damage this unit internally or may not securely install the unit in place. This may cause parts to become loose resulting in hazards or product failure.
- **ARRANGE THE WIRING SO IT IS NOT CRIMPED OR PINCHED BY A SHARP METAL EDGE.** Route the cables and wiring away from moving parts (like the seat rails) or sharp or pointed edges. This will prevent crimping and damage to the wiring. If wiring passes through a hole in metal, use a rubber grommet to prevent the wire's insulation from being cut by the metal edge of the hole.
- **DO NOT INSTALL IN LOCATIONS WITH HIGH MOISTURE OR DUST.** Avoid installing the unit in locations with high incidence of moisture or dust. Moisture or dust that penetrates into this unit may result in product failure.



- Use a soft dry cloth for periodic cleaning of the product. For more severe stains, please dampen the cloth with water only. Anything else has the chance of dissolving the paint or damaging the plastic.
- Be sure the temperature inside the vehicle is between +45°C (+113°F) and 0°C (+32°F) before turning your unit on.
- If you have problems, do not attempt to repair the unit yourself. Return it to your Alpine dealer or the nearest Alpine Service Station for servicing.

Warning and Notices



- This device should never be mounted in or to a vehicle in a way that interferes with the operations of the vehicle, including, but not limited to, airbags, lane detection systems, navigation device, and so forth. Doing so may result violation of state or national laws, injury, or death. Always mount this device so that it does not obstruct the driver's view. Any fines, penalties, or damages resulting from improperly or illegally operating this device are not the responsibility of Alps Alpine Co., Ltd. or any of its affiliates, subsidiaries, principals, officers, employees or shareholders.
- Do not operate or manipulate this device while driving, such as change settings, review footage, access information, change the device location or angle, or otherwise manipulate this device while driving. Do not allow this device to distract from safe driving.
- Do not mount this device where driver or passenger head impact is likely in the case of an accident, including, but not limited to areas directly in front of the driver or passengers.
- It may be a violation of state or national laws to secure this device to a dash board or windshield. It is the user's responsibility to know and follow the applicable laws in the jurisdictions where this device is used.
- Do not use this device contrary to the instructions in this manual or contrary to national and state laws.
- It may be a violation of state or national laws to video or audio record someone with this device without their consent. This may include audio recording a passenger in your vehicle without his or her consent. It is the user's responsibility to know and follow the applicable laws in the jurisdictions where this device is used.
- Publishing the recordings made with this device on social media or other places on the internet without consent of those in the recordings may violate state or national privacy laws. It is the user's responsibility to know and follow the applicable laws in the jurisdictions where this device is used.
- This product uses lithium batteries. For your safety, do not overcharge this device. Do not leave this device plugged in when the vehicle is not turned off. Do not leave this device in extreme temperatures. Damaged, overcharged, or misused lithium batteries can explode or otherwise cause fire. Failure to heed these warning may result in injury or death.

1. Product overview

1.1 Included items

Ensure that all the items are included when you open the product box.



The standard items may change without prior notice.

1.1.1 DVR-C320R (2 camera, USA/Canada only)

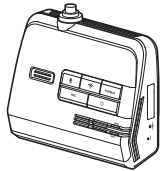

Front camera (main unit)

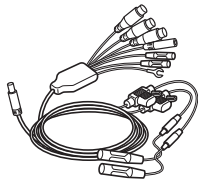

Hardwiring cable



Cable clamp holder



microSD card with adapter (consumable)



Quick start guide /
User guide / Warranty /
Registration card
(stored in the microSD card)



Dash cam recording
warning sticker



Car charger



Rear camera

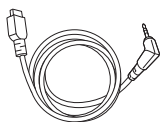

Rear camera cable



Rear camera extension cable

1.1.2 DVR-C320S (1 camera)

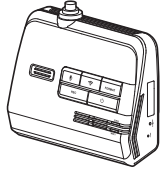

Front camera (main unit)

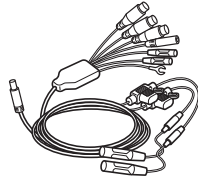

Hardwiring cable



Cable clamp holder

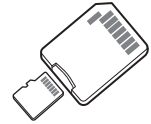

microSD card with adapter (consumable)



Quick start guide /
User guide
(stored in the microSD card)



Dash cam recording
warning sticker



Car charger

1.1.3 RVC-C320 (Rear view only)



Rear camera

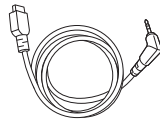

Rear camera cable

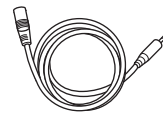

Rear camera extension cable





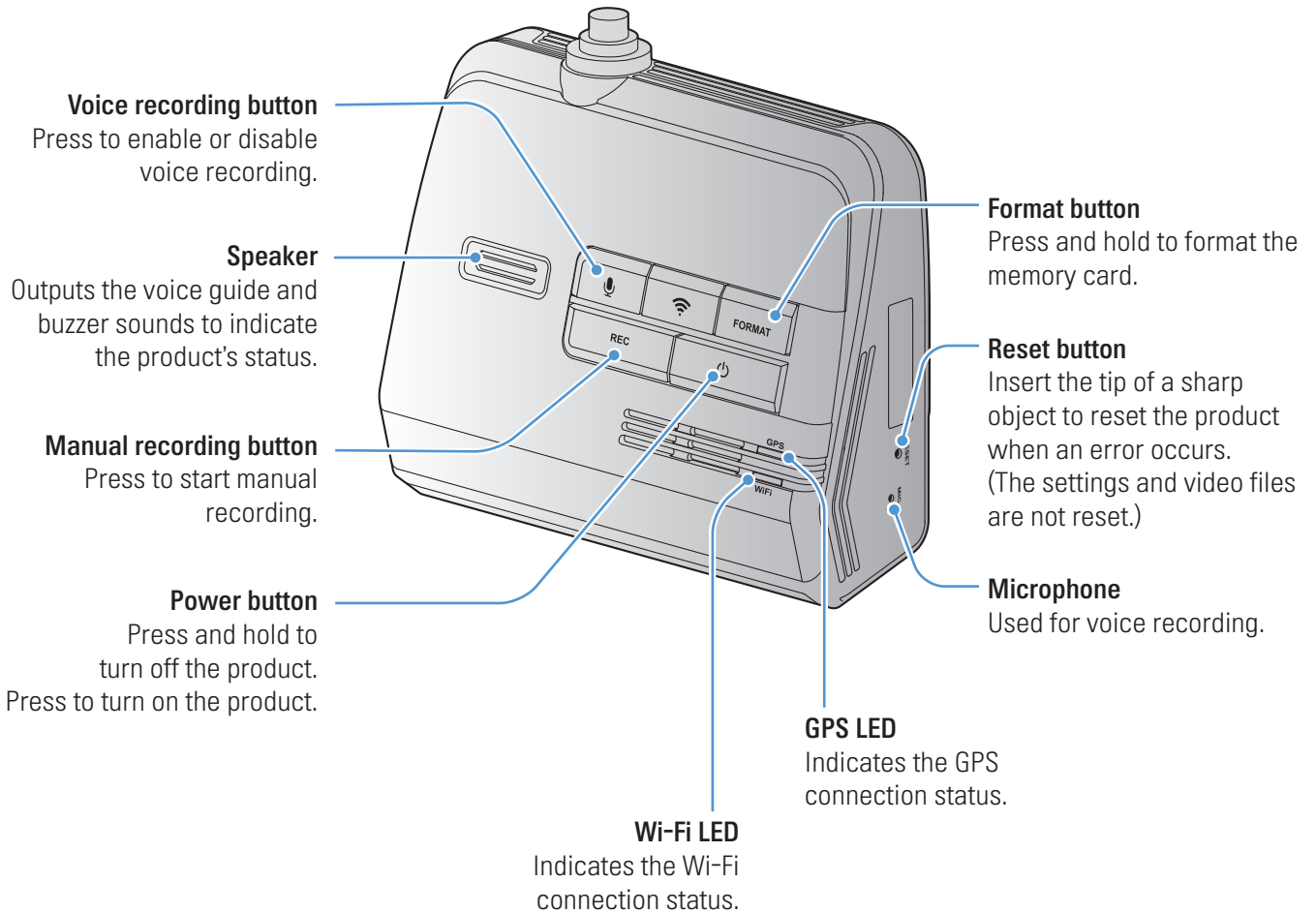

Cable clamp holder

1.2 Part names

1.2.1 Front camera (main unit) - front view



Refer to the following table to check the status of the product using the LED indicators.

LED	LED STATUS	Operation description
Security LED	 (flickers)	The product is turned on.
Wi-Fi LED	 (light on)	Wi-Fi has been connected.
	 (flickers)	Wi-Fi connect enabled.
GPS LED	 (light on)	GPS has been connected.
	Off	GPS has been disconnected.

1.2.2 Front camera (main unit) - rear view

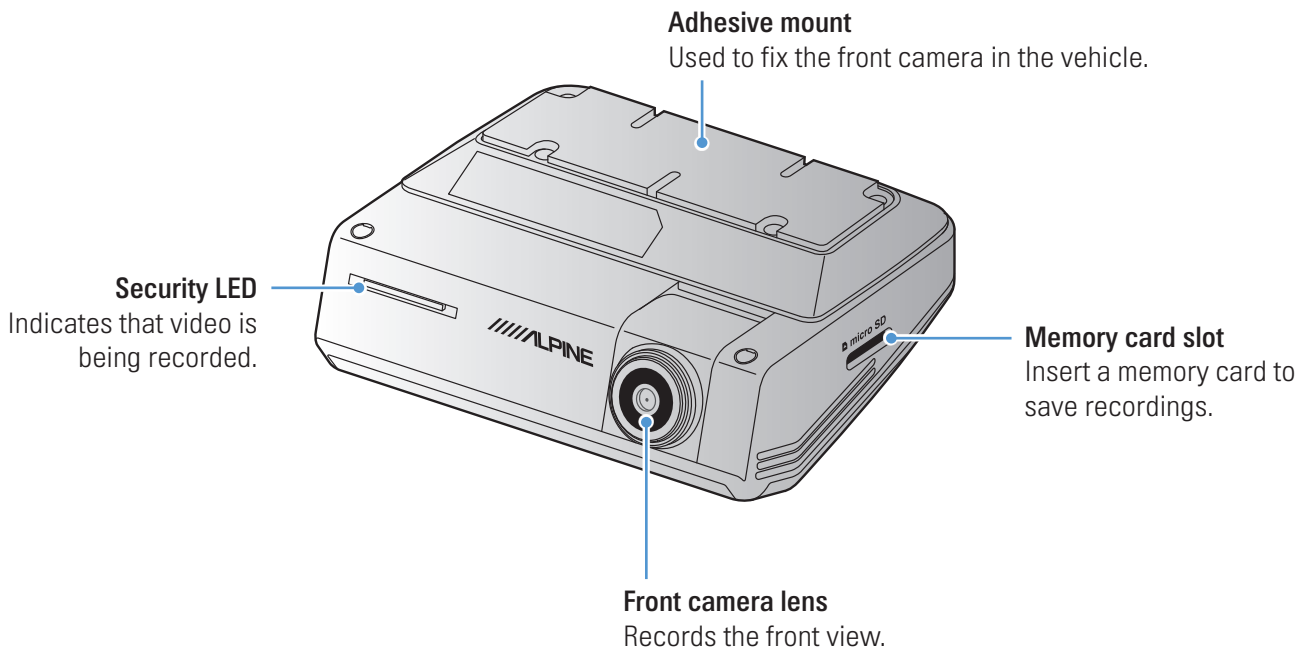

1.2.3 Rear camera (RVC-C320)

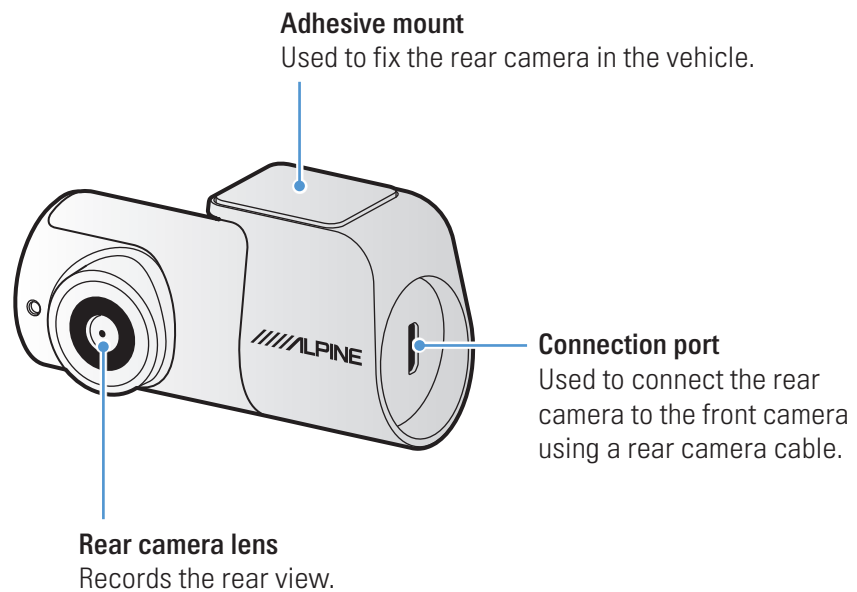

1.3 Removing and inserting the memory card

Follow the instructions to remove the memory card from the product or to insert the memory card into the product.

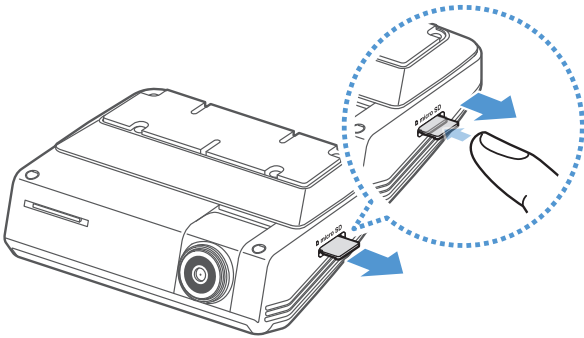

Before removing the memory card, ensure that the product is turned off. Gently push the bottom of the memory card with your fingernail to release it, and then remove it from the product.

To insert the memory card into the memory card slot, ensure that the metal contacts on the memory card are facing toward the product's buttons, and insert it into the slot until you hear a click.



- Ensure that the product is turned off before removing the memory card. The recorded video files may be corrupted or lost if you remove the memory card while the product is on.
- Ensure that the memory card is in the correct direction before inserting it into the product. The memory card slot or the memory card may be damaged if it is inserted incorrectly.
- Use only authentic memory cards from Alpine. Alpine does not guarantee the compatibility and normal operation of third-party memory cards.



To prevent loss of recorded video files, periodically back up the video files on a separate storage device.

1.4 Basic connection diagrams

1.4.1 Connecting the product

Configure the product correctly according to the connection diagram.



The connection diagram is for reference only. The product must be professionally installed in the vehicle by an Alpine authorized dealer/a trained specialist mechanic.

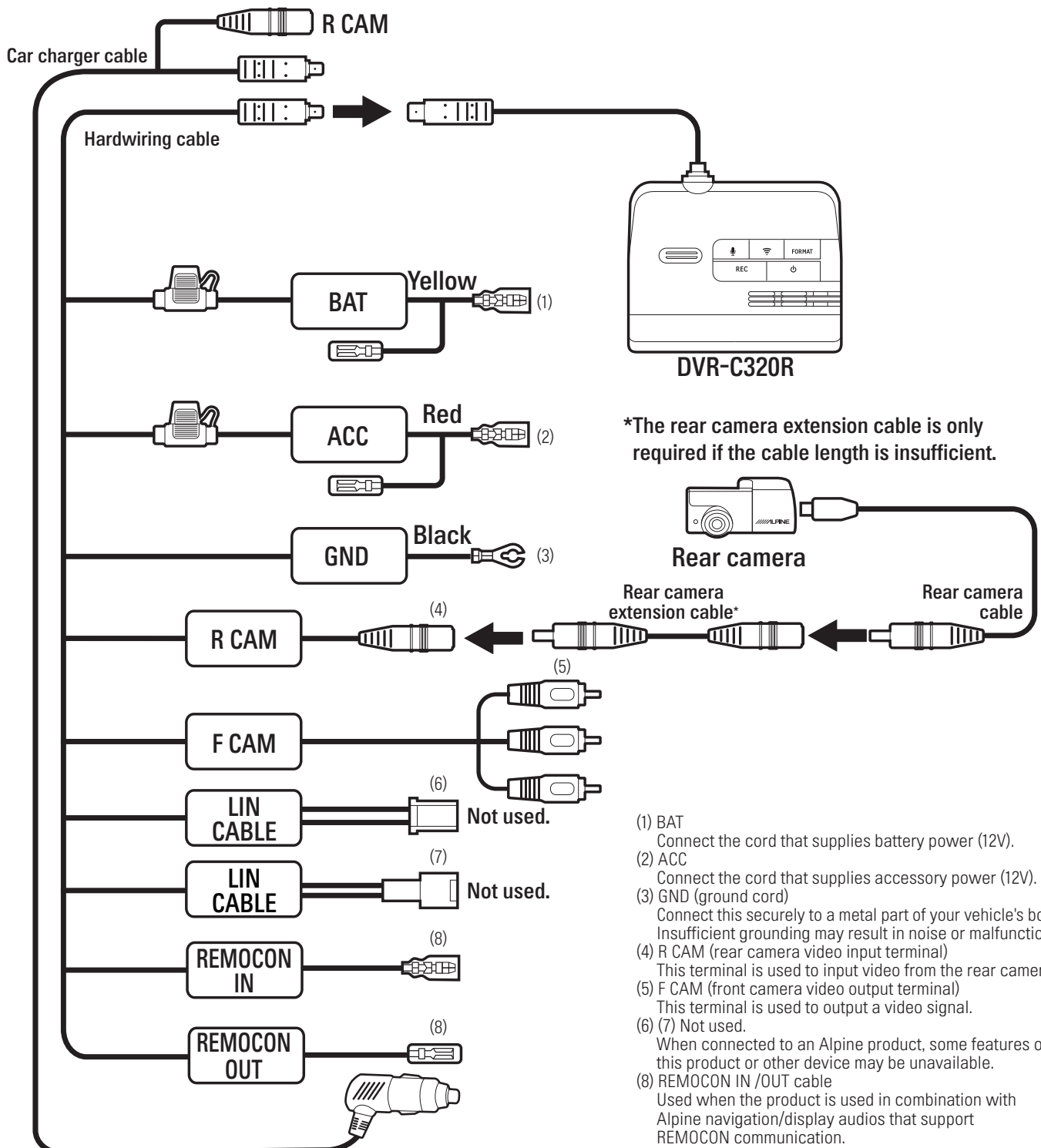

1.4.2 Connecting the dash cam to the Alpine navigation/display audio system

Follow the connection diagram to use the Alpine navigation/display audio's features with the dash cam.

 The dash cam and other accessories which need a REMOTE IN/OUT connection cannot connect to the Alpine navigation/display audio system at the same time.

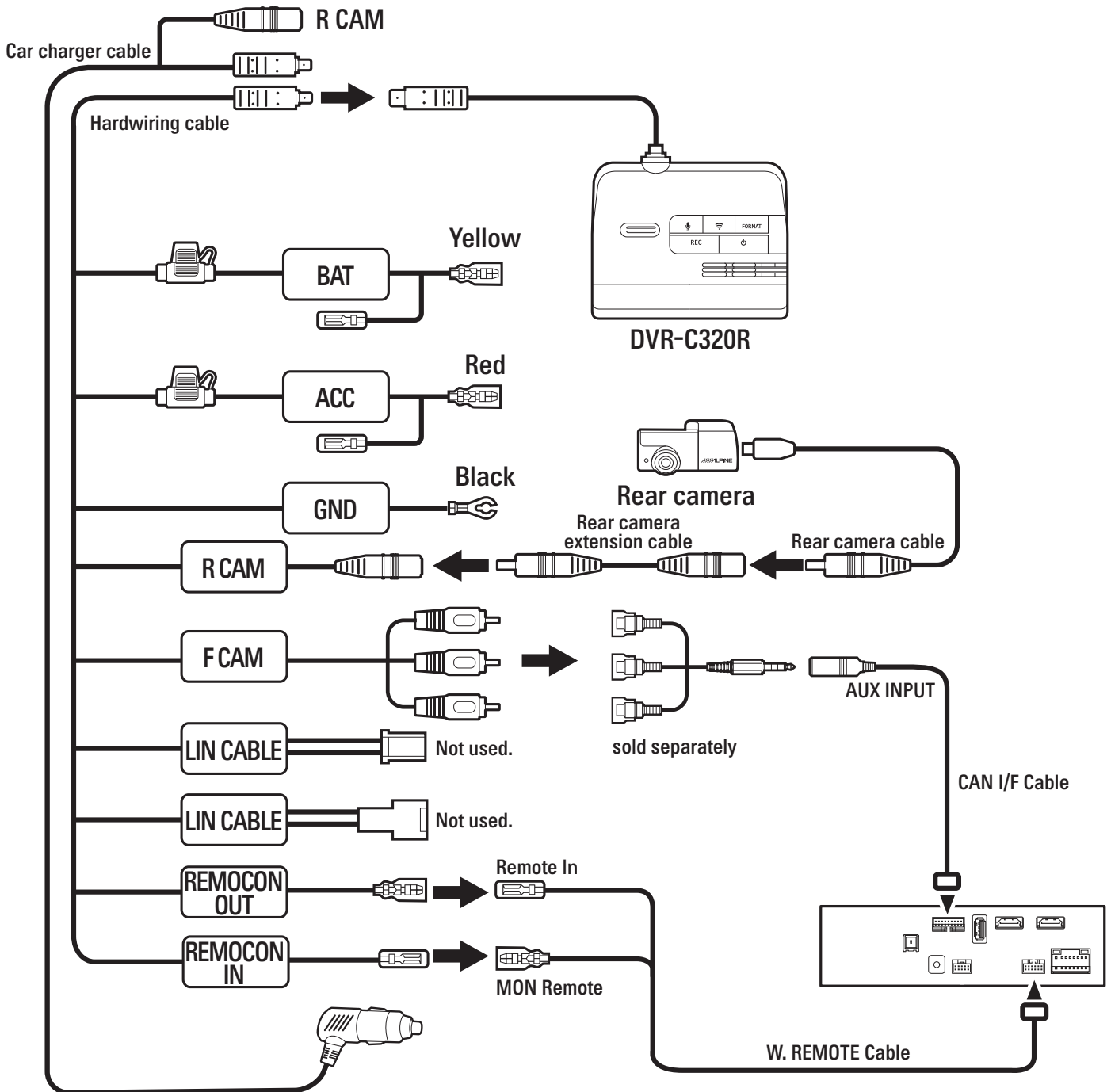

1.4.3 Setting the auxiliary (AUX) name of the navigation/display audio system

On the Source setting screen, set AUX to **On**, and then set the AUX name to **Dash Cam**. For details on operating the navigation/display audio system, refer to its owner manual.



The latest AV(N) firmware must be installed.

1.4.4 ADAS warning message

When the Front Vehicle Departure Warning or Back Collision Warning System features are enabled, the ADAS warning message will be displayed on the navigation/display audio system depending on the vehicle's status in traffic.



- For your safety, the Dash Cam's screen or movies are not displayed on the navigation/display audio system while driving.
- The ADAS warning message is displayed on the navigation/display audio system while driving.

2. Installing the product

2.1 Installing the front camera (main unit)

Follow the instructions to properly install the product.

2.1.1 Selecting an installation location

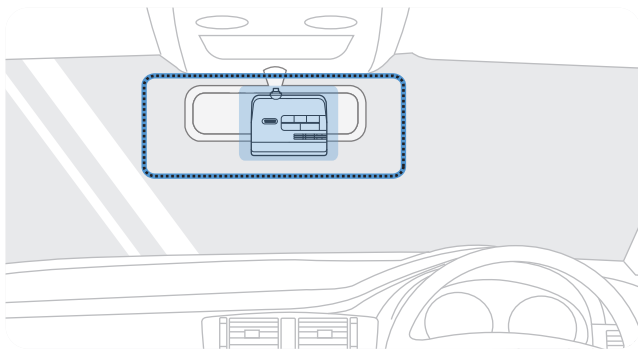

Select an installation location that can record the entire view in front of the vehicle without obstructing the driver's vision. Ensure that the front camera lens is located in around the center of the windshield.

Should not be installed on vehicle equipped with front radar or front camera ADAS systems.

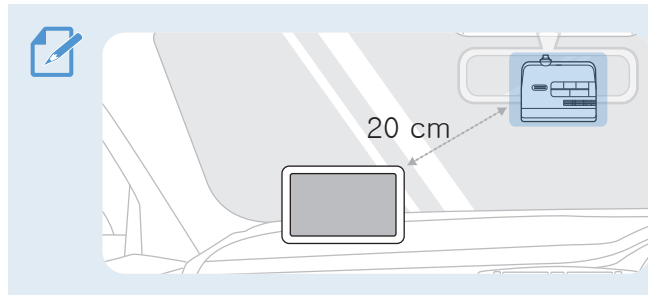

If a GPS navigating device is installed on the dashboard, its GPS reception may be affected depending on the dashboard camera's installation location.

Adjust the installation location of the GPS navigating device to ensure that the two devices are separated by at least 20 centimeters (approximately 8 inches).

2.1.2 Securing the product

Follow the instructions to secure the product at the installation location.

- 1 After determining the installation location, wipe the installation location on the windshield with a dry cloth.

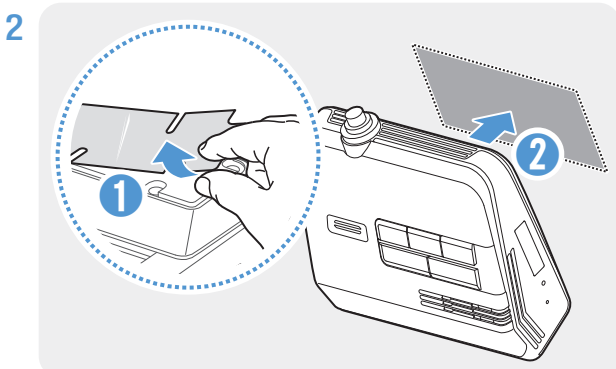

Remove the protective film from the bottom of the product, and then attach the product to the installation location.

3

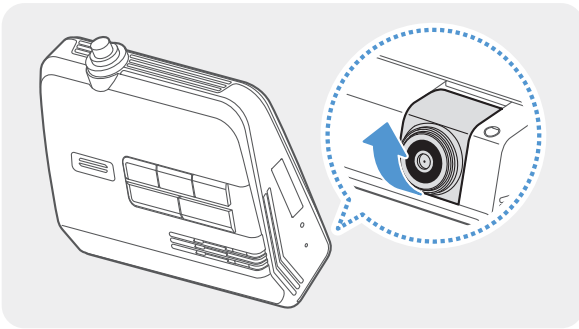

Set the vertical angle of the camera appropriately.



To confirm the camera angle, record a video after installation and check the video using the Alpine navigation/display audio system or the ALPINE Recording Viewer application. If necessary, adjust the camera angle again.

2.2 Installing the rear camera

Refer to the following instructions to properly install the rear camera.

2.2.1 Selecting an installation location

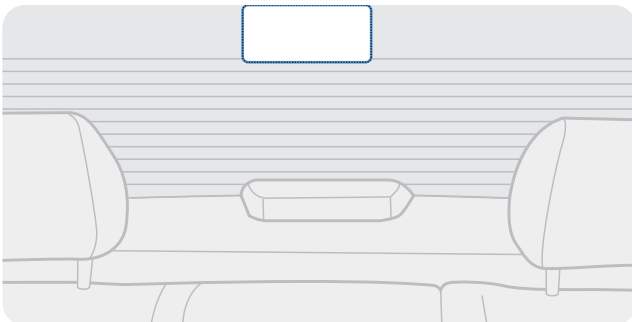

Select a location on the rear windshield where there is no defrost grid wire and the camera can record the entire rear view.



- For vehicles with a sunshade attached to the rear windshield, you must select a location where using the sunshade will not interfere with camera operation.
- The adhesive part of the rear camera should not touch the defrost grid.

2.2.2 Securing the rear camera

Refer to the following instructions to secure the product to the installation location.

- 1 After determining the installation location, wipe the installation surface of the windshield with a dry cloth.



Check the installation location before you secure the rear camera to the rear windshield. After securing the rear camera to the windshield, it is hard to remove the camera or change the installation location due to the strong adhesive.

2

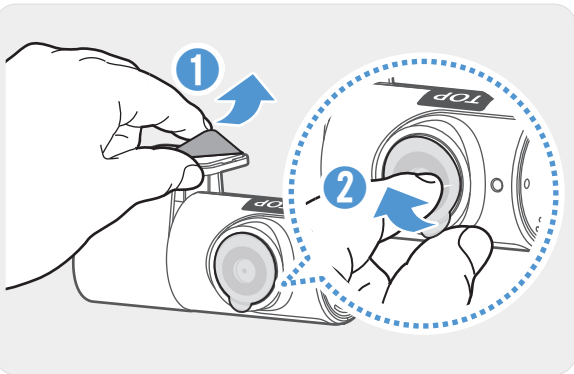

Remove the protective film from the adhesive mount and camera lens.



Before attaching the rear camera, check the position of the lens. The **TOP** label should be above the lens.

3

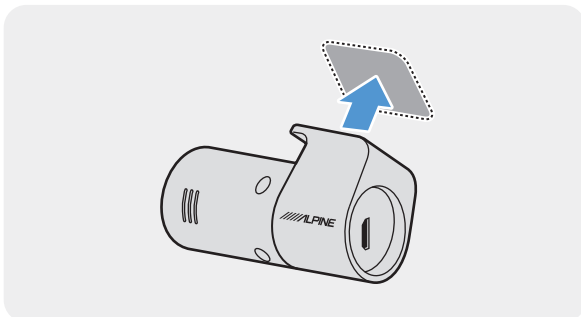

Attach the product with the Alpine logo facing inside the vehicle and press the adhesive tape firmly to secure the camera.



If the product is installed in reverse, the rear view will be recorded upside down.

4

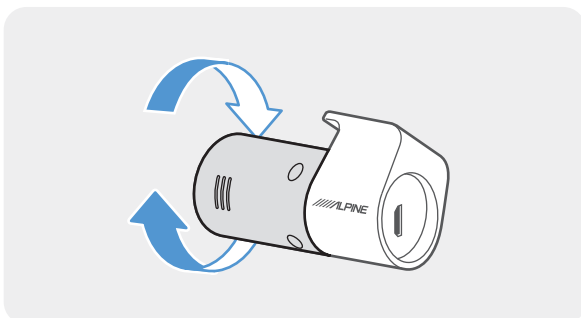

Adjust the camera's vertical angle.

2.2.3 Connecting the rear camera cable

Power off the product and connect the rear camera cable to the front camera (main unit).

1

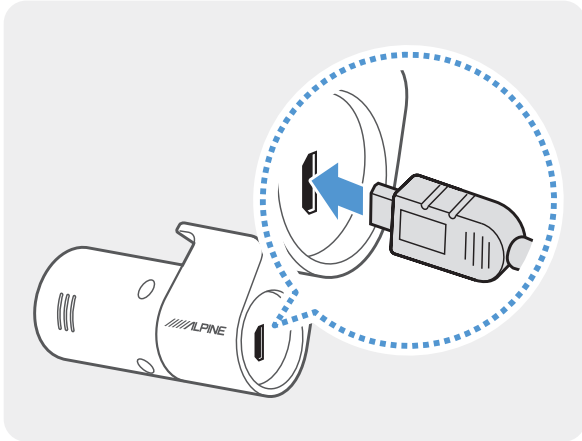

Connect the other end of the rear camera cable to the rear camera's connection port.



For safe driving, arrange the cables to prevent the driver's vision from being obstructed or interfering with driving.

- 2 Connect the rear camera cable to the power cable's R CAM terminal.
- 3 Turn on the ACC or start the engine to check if the product is powered on. After the product is powered on, the voice guidance will be turned on.



The product is powered on when the ACC mode is turned on or when the engine starts.

3. Using recording features

3.1 Turning the product on or off

The product is turned on automatically and continuous recording starts when you turn on the ACC or start the engine. To power off the product, press and hold the Power button. To turn the power back on, press the Power button again.



Wait until the product is completely booted up after turning it on, and then begin operating the vehicle. The video recording does not begin until the product is completely turned on (booted up).

3.2 Learning about file storage locations

Videos are stored in the following folders according to their recording mode.

The Alpine navigation/display audio system	Continuous	Continuous Incident	Manual Recording	Motion Detection	Parking Incident
In the memory card	cont_rec	evt_rec	manual_rec	motion_ timelapse_rec	parking_rec



Play videos on Window/Mac computer or using the **ALPINE Recording Viewer** application. If you play videos by inserting the memory card in devices such as a smartphone or a tablet PC, the video files may be lost.



A file name is composed of the recording start date and time, and the recording option.

REC_	YYYY_MM_DD	HH_MM_SS	F
REC_	2020_07_01	10_25_30	R

Recording conditions

- F: Front camera
- R: Rear camera

3.3 Using the continuous recording feature

Connect the power cable to the product's DC-IN power port and then turn on the vehicle's electrical accessories or start the engine. The voice guide will indicate that continuous recording has started.

During continuous recording, the product operates as follows.

Mode	Operation description
Continuous recording	During driving, videos are recorded in 1 minute segments and stored in the "cont_rec" folder.
Incident continuous recording*	When an impact to the vehicle is detected, a video is recorded for 20 seconds (from 10 seconds before the detection to 10 seconds after the detection) and stored in the "evt_rec" folder.

* When an impact to the vehicle is detected during continuous recording, incident continuous recording starts with a double beep sound.



- The video recording does not begin until the product is completely booted up and the GPS signal is received. After the booting up is finished you may begin operating the vehicle.
- When incident continuous recording starts, a double "beep" sounds as a notification.
- To enable recording, you must insert a memory card into the product.

3.4 Recording manually

You can record a scene you want to capture while driving and store it as a separate file.

To start manual recording, press the manual recording (**REC**) button. Then, the voice guide will indicate that manual recording has started.

During manual recording, the product operates as follows.

Mode	Operation description
Manual recording	When you press the manual recording (REC) button, a video will be recorded for 1 minute (from 10 seconds before to 50 seconds after pressing the button) and stored in the "manual_rec" folder.

3.5 Using parking mode

When the product is connected to the vehicle via the hardwiring cable, the operating mode is switched to parking mode after the engine or electrical accessories are turned off and the voice guide will indicate that the parking mode has started.



- Parking mode operates only when the hardwiring cable is connected. The hardwiring cable must be professionally installed to the vehicle by an Alpine authorized dealer/a trained specialist mechanic.
- To use all recording modes, you must insert a memory card into the product.
- Depending on the battery charging status of the vehicle, the duration of parking mode may differ. If you want to use parking mode for an extended period, check the battery level to prevent battery depletion.

Refer to the following table to set the parking mode options.

Option		Operation description
Motion Detection	No motion or impact detected	Monitors movement in the area or impacts to the vehicle. Video will be recorded only when motion or an impact is detected.
	Motion detected	When a moving objects is detected while parking, a video is recorded for 20 seconds (from 10 seconds before detection to 10 seconds after detection) and stored in the "motion_timelapse_rec" folder.
	Impact detected	When an impact is detected while parking, a video is recorded for 20 seconds (from the moment 10 seconds before detection to 10 seconds after detection) and stored in the "parking_rec" folder.
Time Lapse	No impact detected	A videos is recorded at a rate of 2 fps for 10 minutes, compressed into a 2-minute long file, and stored in the "motion_timelapse_rec" folder. Since the video file recorded with this option is small, you can record a long video.
	Impact detected	When an impact is detected while parking, a video is recorded for 100 seconds at a rate of 2 fps (from the moment 50 seconds before detection to 50 seconds after detection) and stored in the "parking_rec" folder after being compressed into a 20-second long file. (The buzzer will sound.)
Energy Saving	No impact detected	Monitors impacts to the vehicle. Video will be recorded only when an impact is detected.
	Impact detected	When an impact is detected while parking, a video is recorded for 20 seconds (from within 1 second after detection) and stored in the "parking_rec" folder.
OFF		The product is powered off when electric accessories and the engine are turned off.



If parking mode settings are changed, the videos recorded with the previous settings will be deleted. To prevent data loss, back up all parking mode videos before changing parking mode settings.





You cannot use Motion Detection, Time Lapse, or Energy Saving at the same time.

3.6 Using the Super Night Vision

With the Super Night Vision feature, you can record videos that are much brighter than videos recorded without this feature. This feature is enabled by real-time image signal processing (ISP) to improve the brightness of recorded videos, both while driving and parking at night.

3.7 Using the road safety features

The road safety features include a lane departure warning system (LDWS), a forward-collision warning system (FCWS), a low speed Forward collision warning system (low-speed FCWS), Back collision warning system (BCW) and a front vehicle departure warning (FVDW).

Safety feature	Description
LDWS (Lane Departure Warning)	Detects lane departure and warns the driver (Beep).
FCWS (Forward Collision Warning)	Detects threats ahead and warns the driver (Beep) when the vehicle is moving at 30 km/h or above.
Low Speed FCWS	Detects threats ahead and warns the driver (Beep) when the vehicle is moving between 10-30 km/h.
BCW (Back Collision Warning)	Detects rear collision threats, warns the driver (Beep), and records video when the vehicle is moving at 50 km/h or above and another vehicle remains within 10 m of the rear of the vehicle for 5 seconds.  <ul style="list-style-type: none"> • When connected to the Alpine navigation/display audio system, a warning message will pop up on the navigation/display audio display. • BCWS videos are saved in the “evt_rec” folder with “BC” added after the file name.
FVDW (Front Vehicle Departure Warning)	Notifies the driver (Beep) when another vehicle in front of the vehicle has started moving after it had been stopped there for 4 seconds or longer.  <ul style="list-style-type: none"> • When connected to the Alpine navigation/display audio system, a warning message will pop up on the navigation/display audio display.



Road safety features are performed differently depending on the set speed and sensitivity of the features.

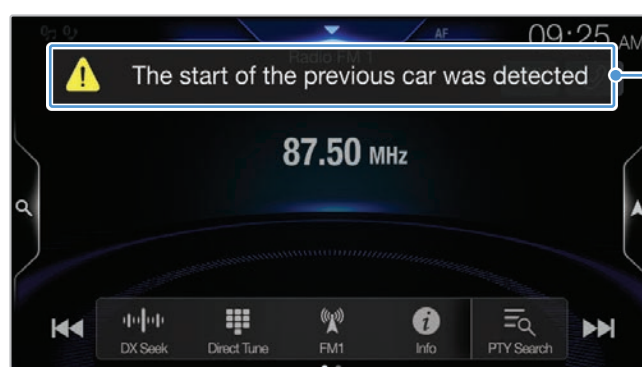

Warning message

4. Operating on the Alpine navigation/display audio system

4.1 Screen layout

The following is an explanation of the Live view and Home screen layout.



For safety reasons, the screen is not displayed while the vehicle is moving.



- The features that are linked with the Navigation/Display Audio system are supported by the Product the were produced in 2020 or later(Please confirm the Alpine website.)
- Depending on when the product model was shipped, program updates may be required.

4.1.1 Live view screen

On the Live view screen, you can view the currently recorded videos and operate the product by tapping on the Alpine navigation/display audio system display. The Live view screen is displayed when you turn on the ACC and start the engine.

The screenshot shows a live video feed of a road. At the top right, there is a smaller inset video showing a rear camera view. At the bottom, there is a black status bar with several icons and text. Callouts with blue lines point to various elements:

- Home icon:** Move to the Home screen.
- Speed and Voltage:** Displays the current vehicle speed. (120 km/h, 15.5V)
- Battery Voltage:** Displays the current battery voltage.
- GPS icon:** Displays the GPS icon.
- Recording Status:** Displays the current recording status. (Continuous)
- Date and Time:** Displays the current date and time. (2020.05.25 AM 0:30)
- REC icon:** Start manual recording.
- Rear Camera View:** Displays the video that the rear camera is recording. Tap the screen to display full screen.
- Front Camera View:** Displays the video that the front camera is recording. Tap the screen to hide or display the Menu buttons.



Wait until the product is completely booted up after turning it on, and then begin operating the vehicle. The video recording does not begin until the product is completely turned on (booted up).

4.1.2 Home screen

Move to the Home screen by tapping the Home (🏠) button on the Live view screen.

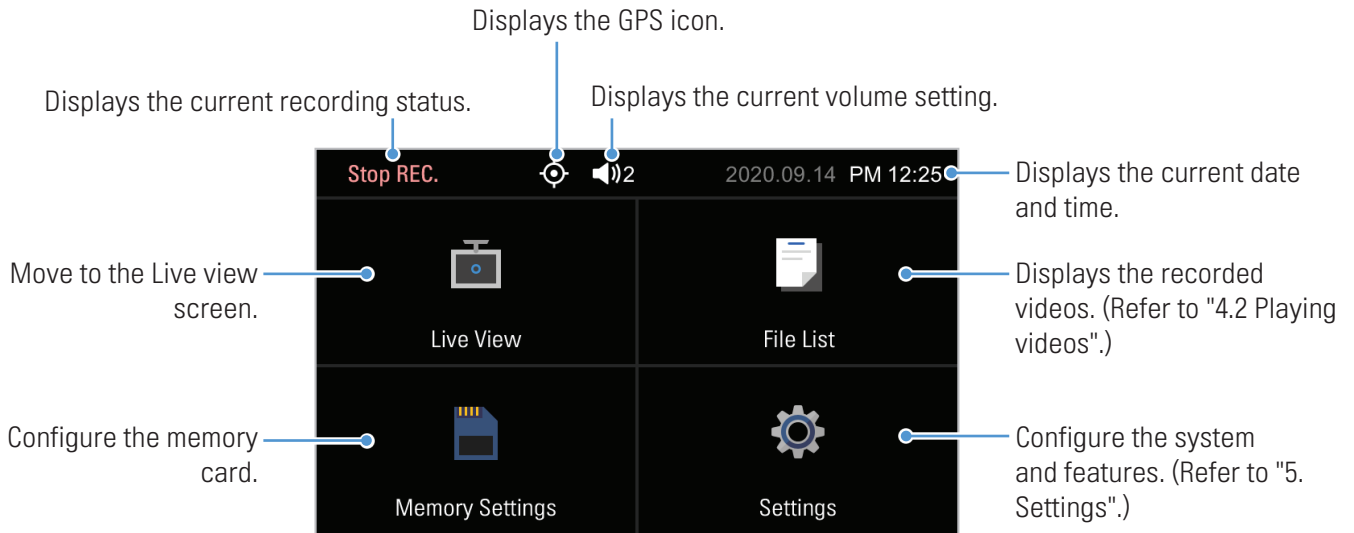

- Stop your vehicle in a safe location before operating the product.
- While operating the Home screen, the product will stop recording.
- Play videos saved on the memory card using the Alpine navigation/display audio system or by using the ALPINE Recording Viewer app on a PC or smartphone. If you attempt to play videos by inserting the memory card into a device such as a smartphone or a tablet PC, the video files may be lost.

4.2 Playing videos

You can play videos on the Alpine navigation/display audio system. Follow the instructions below to play videos.

4.2.1 Playing on the Alpine navigation/display audio system

- 1 On the Live view screen, tap the Home (🏠) button > **File List**. The number of videos categorized by the recording mode will be displayed.

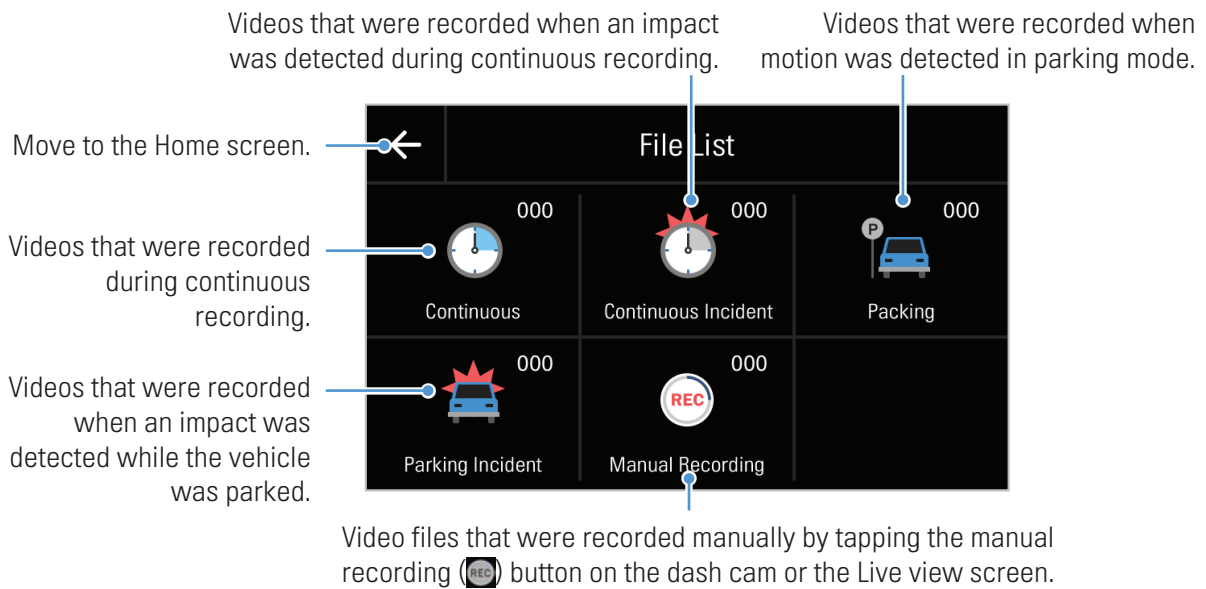

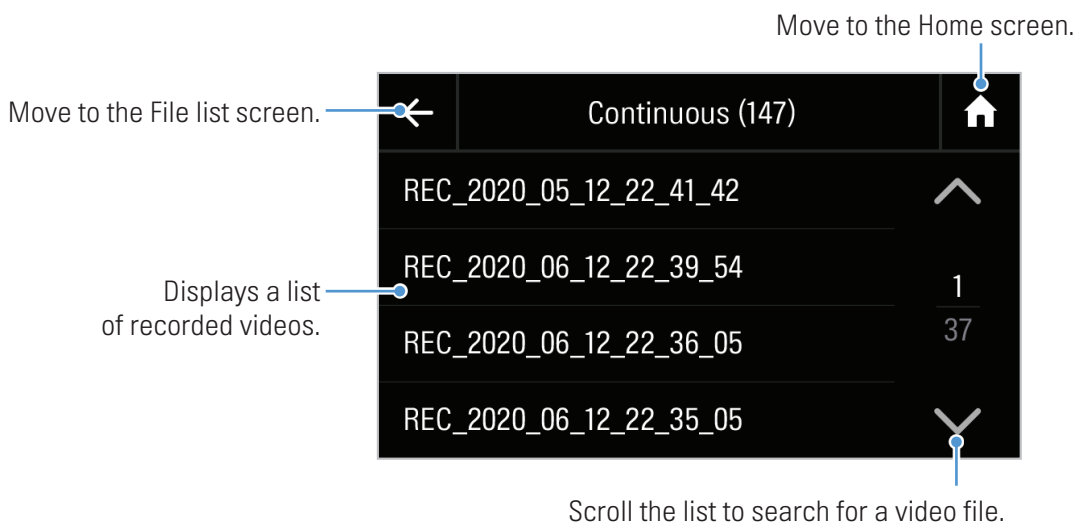

- 2 When you tap a category, the video file list will appear. Select the video you want to play.



3 Tap a button on the playback screen to control the video player or other functions.

 If you touch the playback area of the Alpine navigation/display audio system, the screen will be switched to full screen mode. To exit full screen mode, touch the screen again.





Move to the File list screen. 

Switch to the rear camera video view. 

Videos are played here. Tap the screen to hide or display the Menu buttons.

Displays the playback status. 



Turn the video sound on or off. 

Play the previous file. 

Play or pause a video. 

Play the next file. 

Magnify the current video by 3 times.

-  : Move in the selected direction
-  : Close the magnification screen



- 
- While you are checking the video file list or playing a video, the product will stop recording.
 - Play videos saved on the memory card using the Alpine navigation/display audio system or by using the ALPINE Recording Viewer app on a PC or smartphone. If you attempt to play videos by inserting the memory card into a device such as a smartphone or a tablet PC, the video files may be lost.
 - During playback, it may not be possible to identify vehicle license plate numbers due to the vehicle's relative speed or lighting conditions.

 • A file name is composed of the recording start date and time, and the recording option.

YYYY_MM_DD	HH_MM_SS	
REC_2020_07_01	10_25_30	F
REC_2020_07_01	10_25_30	R

Recording conditions

- F: Front camera
- R: Rear camera

- If the memory card storage gets shortened while recording, the previously recorded videos are deleted for storage sufficiency. To prevent data loss, back up important videos on additional storage devices.
 - **When the continuous recording storage is insufficient:** The oldest continuous recording file will be deleted and replaced with a new video file. Event video files (incident recording and manual recording files) will not be deleted.
 - **When the storage is insufficient (for event video files only):** Event video files will be deleted chronologically from oldest to most recent.

4.3 Managing the memory card

On the Live view screen, tap the Home  button > **Memory Card Settings**.

Options	Description
Partition Settings	You can partition the memory card to adjust the storage space for different types of video recordings. Select from Cont. Rec Priority/Incident Rec Priority/Parking Rec Priority/Manual Rec Priority/Driving Rec Only for the memory partition type.
Formatting Memory	You can format the memory card that is inserted in the product. In Formatting Memory , tap Format > Confirm to proceed with formatting the memory card.



Do not disconnect the power or remove the memory card from the product while partitioning or formatting. Doing so may cause serious damage to the data stored in the memory card.

5. Settings



For safety reasons, the screen is not displayed while the vehicle is moving.

You can use the Alpine navigation/display audio system to configure the product features according to your needs and preferences. The following procedure is the procedure when using the Alpine navigation/display audio system.

On the Live view screen, tap the Home (🏠) button > **Settings**.

Move to the Home screen.

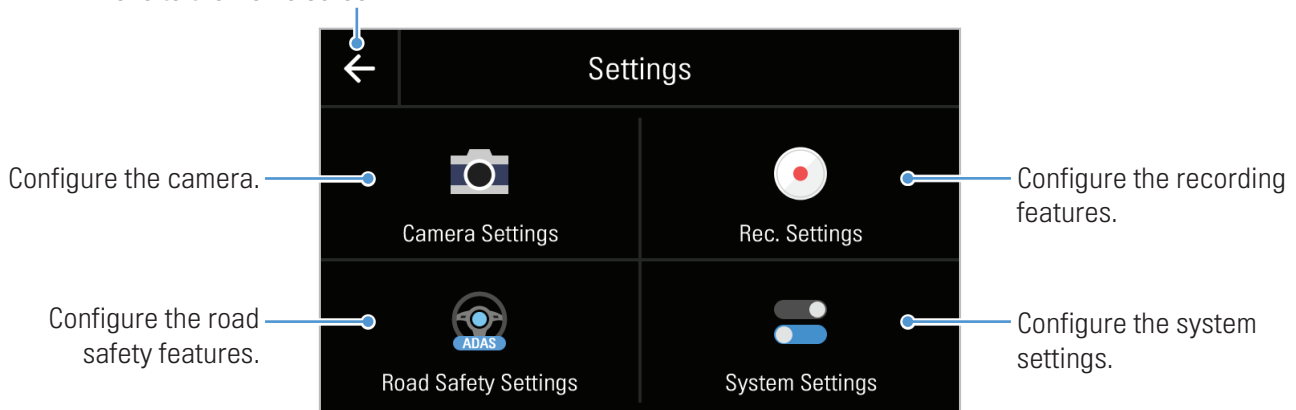

The product stops recording while it is being configured from the Alpine navigation/display audio system.

5.1 Setting the Camera

On the Settings screen, tap **Camera Settings**.

Options	Description
Brightness-front	You can set the brightness of the front view recording. Select from Dark/Mid/Bright for the brightness of the front camera.

5.2 Setting recording features

On the Settings screen, tap **Record Settings**.

Options	Description
Voice Recording	Select from ON/OFF for voice recording.
Cont. Sensitivity	You can set the detection sensitivity for recording when an impact is detected while driving. When you set the sensitivity, you must consider the road conditions, traffic situation, or your driving style. Select from OFF/Lowest/Low/Mid/High for the sensitivity.
Super Night Vision	You can record bright and high resolution videos at night if you activate the Super Night Vision feature. Select from Continuous Mode/Parking Mode for the Super Night Vision mode.
HDR	You can activate the HDR (high dynamic range) feature when recording a video. Select from ON/OFF for the HDR feature.
Set Privacy Recording	You can set the privacy recording feature to delete your recorded files after a set amount of time to protect the privacy of others. Select from OFF/1min(max. 2min)/3min(max. 4min) for the privacy recording setting.  This feature is only available in Europe.
Parking Mode	You can set the operating mode of the product while the vehicle is parked. Select from OFF/Motion Detection/Time Lapse/Energy Saving for the parking mode.
Parking Sensitivity	You can set the detection sensitivity for recording when impact is detected while parking. Select from Lowest/Low/Mid/High/Highest for the sensitivity.
Motion Sensitivity	The motion detection feature records a video when a moving object is detected near your vehicle. Select from Lowest/Low/Mid/High/Highest for the sensitivity.
Off Timer	When you activate the record timer feature, the product will record a video in parking mode for a preset time. Select from 3 Hrs./6 Hrs./12 Hrs./24 Hrs./48 Hrs./72 Hrs. for the recording time.
Off Voltage	You can set the battery protection voltage. Select from 12V (11.6-12.3) for the voltage.
Wt Bty Protection	To protect the battery in wintertime, you can turn off the power at a voltage that is +0.2V higher than the voltage set in the Battery cutoff voltage. Select the month(s) to apply the battery protection feature.



- To use parking mode, you must install the hardwiring cable. If continuous power is not supplied to the product, the product will stop recording when the vehicle engine is turned off.
- The vehicle's battery will not be charged while the vehicle is parked. If you record in parking mode for an extended period, the vehicle's battery may be depleted and you may not be able to start the vehicle.



- For more information about parking mode, refer to "3.5 Using parking mode" on page 22.
- If the off voltage value is too low, the product may consume the battery completely depending on various conditions, such as the vehicle type or temperature.

5.3 Setting road safety features

On the Settings screen, tap **Road Safety Settings**.

Options	Description
Safety Cameras	When the vehicle approaches or passes the speed limit zone, the safety camera alert system will collect GPS signals and safety camera data. Select from ON/OFF for the safety camera feature.
Mobile Speed Zone	The mobile zone alert feature audibly warns the driver about speed cameras and mobile speed zones in the driver's area. Select from ON/OFF for the mobile zone alert feature.
Vehicle Type	The sensitivity and operation of the road safety features are adjusted according to the vehicle type. Select from Sedan/SUV/Truck (Bus) for the vehicle type.
ADAS Settings	Adjust the product to align the blue line displayed on the ADAS settings screen with the center of the hood and the green line just above the hood. After positioning the product, drive at 30 km/h for more than 1 minute to finish the alignment.
BCW Guide (Back Collision Warning)	Adjust the rear camera to align the red line displayed on the BCW (Back Collision Warning) guide setting screen with the horizon. After positioning the product, drive at 30 km/h for more than 1 minute to finish the alignment.
Initialize ADAS	Adjust the product to align the blue line displayed on the ADAS settings screen with the center of the hood and the green line just above the hood. You can enhance the ADAS accuracy. Even if there is an error, the sensitivity can be automatically adjusted by driving for several minutes while recording constantly. In Initialize ADAS , tap Reset > Confirm to proceed with initializing.
LDWS (Lane Departure Warning)	Detects lane departure and warns the driver (Beep). Select from OFF/Low/Mid/High for the LDWS sensitivity.
LDWS Speed	You can change the lane departure detection speed. Select the minimum speed for activating warnings: 30mph/ 40mph/ 50mph/ 65mph .
FCWS (Forward Collision Warning)	Detects threats ahead and warns the driver (Beep) when the vehicle is moving at 30 km/h or above. Select from OFF/Low/Mid/High for the FCWS sensitivity.

Options	Description
Low Speed FCWS	Detects threats ahead and warns the driver (Beep) when the vehicle is moving between 10-30 km/h. Select from OFF/Low/Mid/High for the low speed FCWS sensitivity.
BCW (Back Collision Warning)	Detects rear collision threats, warns the driver (Beep), and records video when the vehicle is moving at 50 km/h or above and another vehicle remains within 10 m of the rear of the vehicle for 5 seconds. Select from ON/OFF for the BCWS feature.
BCW speed	You can change the back collision warning system speed. Select the minimum speed for activating warnings: 30mph/ 40mph/ 50mph/ 65mph .
FVDW (Front Vehicle Departure Warning)	Notifies the driver (Beep) when another vehicle in front of the vehicle has started moving after it had been stopped there for 4 seconds or longer. Select from ON/OFF for the FVDW feature.
ADAS Volume	You can adjust the volume of ADAS system warnings. Select the desired ADAS volume level.



- The driver is responsible for safe driving. The driver must not excessively rely on the safe driving warning features. The driver bears responsibility for always being aware of the vehicle's surroundings, and must strive for safe driving.
- The safe driving warning features are intended as support that can warn the driver and help prevent accidents. However, they are not responsible for preventing accidents. In addition, the operation of these features is not completely guaranteed. Be aware that Alpine shall accept no liability for any resulting losses if these features fail to operate.



These features may malfunction due to the vehicle shape and its reflections in the windscreen. If malfunctions occur frequently, adjust so that the reflection is below the horizontal guide line in the ADAS settings, then perform the Initialize ADAS action.

5.4 Configuring the system settings

On the Settings screen, tap **System Settings**.

Options	Description
Language	Select the desired language.
Volume	Select the desired volume level.
Security LED	Select from ON/OFF for the security LED.
Time Zone	Select the desired time zone.
Daylight Saving	Select from ON/OFF for the daylight saving.
Speed Unit	Select from km/h / mph for the speed unit.
Speed Stamp	Select from ON/OFF for the speed stamp.

5.5 Viewing product information

On the Settings screen, tap the system settings.

- Model Name
- Firmware Ver.
- Safety Camera Ver.
- MICOM Ver.
- Memory Size
- Local ID

5.6 Initializing the system settings (Reset Settings)

You can return all system settings to the factory default settings.

- 1 On the Settings screen, tap **System Settings**, and then tap **Reset** to initialize the settings.
- 2 Tap the confirmation button on the confirmation window. All system settings will be initialized.
- 3 When initialization is complete, a confirmation window will appear. Tap the confirmation button to close the window. (If there is no user input, the window will disappear after 5 seconds.)



Do not disconnect the power or remove the memory card from the product while initialization is in progress. Doing so may damage the data stored in the memory card.

6. Using the mobile viewer

You can view and manage recorded videos and configure various product features on your smartphone.



- The following are the mobile phone requirements for using the **ALPINE Recording Viewer** application:
 - Android 7.0 (Nougat) or higher
 - iOS 11.4 or higher
- The Wi-Fi password is required when you connect the product to a smartphone for the first time. Enter “123456789” in the password input field.
- If the hands-free Bluetooth audio feature or phone book transfer feature are used while the mobile viewer is in use, the mobile viewer may temporarily stop functioning, video noise may occur, or the audio may cut out.

6.1 Connect the product to a smartphone

- 1 On your smartphone, open the Google Play Store or Apple App Store and download and install **ALPINE Recording Viewer**.
- 2 Run **ALPINE Recording Viewer**.
- 3 Tap **Dash cam connection is required.** at the bottom of the screen and follow the on-screen instructions to connect the product to a smartphone.

6.2 Viewing the mobile viewer screen layout

The following provides brief information about the mobile viewer’s screen layout.

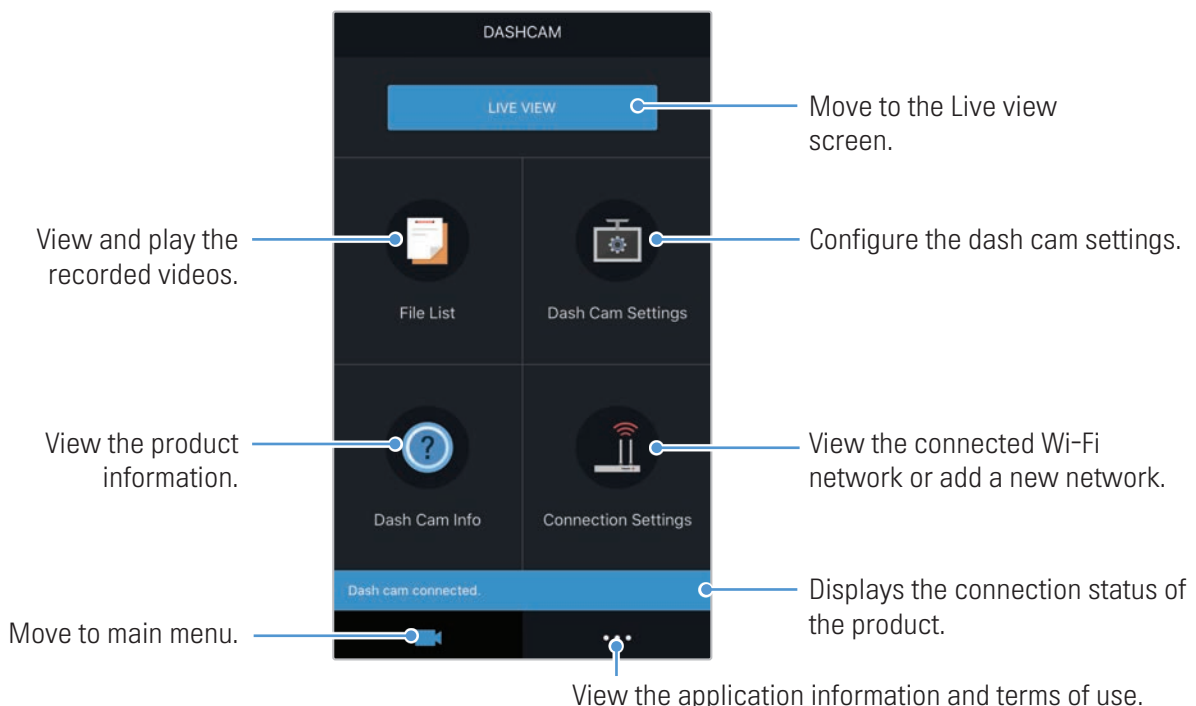

7. Using the PC viewer

You can view and manage the recorded videos and configure various product features on your PC.

7.1 System requirements

The following are the system requirements for running the PC viewer.

- Processor: Intel Core i5, or higher
- Memory: 4 GB or more
- Operating system: Windows 7 or later (64-bit is recommended), macOS X10.8 Mountain Lion or later
- Other: DirectX 9.0 or higher / Microsoft Explorer version 7.0 or higher



The PC viewer will not operate properly on PC systems running an operating system other than those listed in the system requirements.

7.2 Learning about the PC viewer

7.2.1 Installing the PC viewer



You can download the latest PC viewer software from the Alpine website.

The PC viewer installation file (setup.exe) is stored in the root folder of the memory card that is provided with the product. Follow the instructions to install the PC viewer on your PC.

- 1 Insert the memory card into a memory card reader connected to your PC.
- 2 Move the installation file to the desktop, run it, and complete the installation according to the instructions given in the installation wizard.
After the installation is complete, there will be a shortcut icon to ALPINE Recording PC Viewer.

7.2.2 PC viewer screen layout (for Windows)

The following provides brief information about the PC viewer's screen layout.

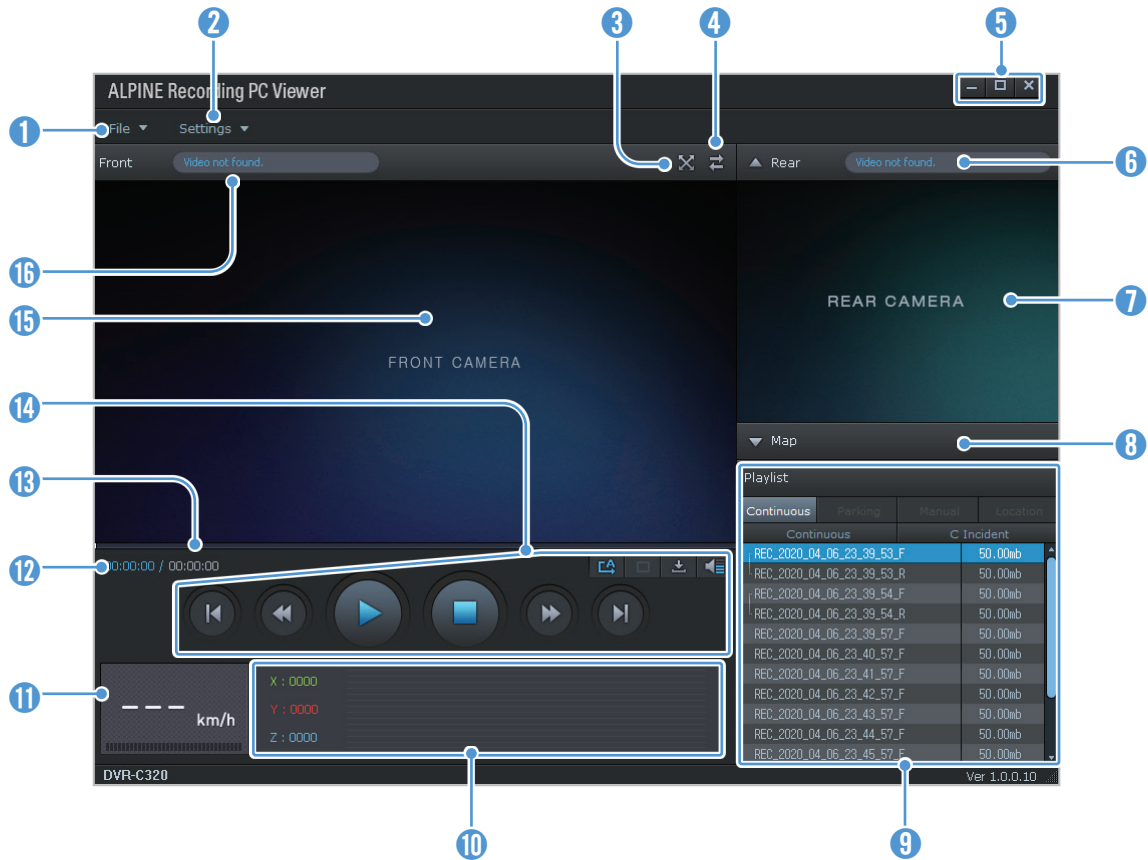

Number	Description
1	Open a file, or save a video with a different name.
2	View or configure the dash cam settings, and set the language for the PC viewer.
3	Display the current video in full screen. Tap the Back  button to return to the previous screen.
4	Switch between the front and rear videos.
5	Minimize, expand, or close the software.
6	Displays the rear camera video file name.
7	Displays the recorded rear camera video.
8	Display the map screen.
9	Displays the playlist.
10	Indicates the G sensor value at the time of recording.
11	Indicates the vehicle's driving speed at the time of recording.
12	Displays the current and total running time of the current video.
13	Displays the progress of video playback.
14	Play or control a video.
15	Displays the recorded front camera video.
16	Displays the front camera video file name.

7.2.3 Playing recorded videos on the PC viewer (for Windows)

Follow the instructions to play recorded videos.

- 1 Turn off the product and remove the memory card.
- 2 Insert the memory card into a memory card reader connected to your PC.
- 3 Double-click the shortcut to the PC viewer to open the program. The video files in the memory card will be automatically added to the playlist in the bottom-right corner of the PC viewer screen. The playlist section layout is as follows.

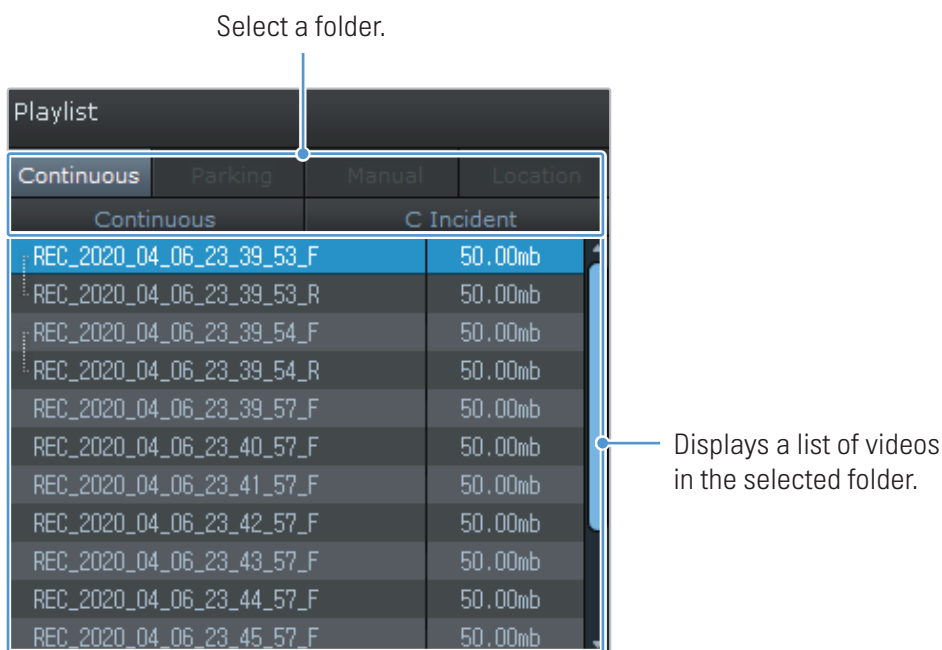

- 4 Double-click a video file after selecting a video folder, or click the Play (▶) button after selecting a video file. The selected video file will be played.

 If the video files on the memory card are not automatically added to the playlist when you run the PC viewer, click **File** ▾ > **Open**, select the removable storage device for the memory card, and click **Confirm**.

7.2.4 PC viewer screen layout (for Mac)

The following provides brief information about the PC viewer's screen layout.

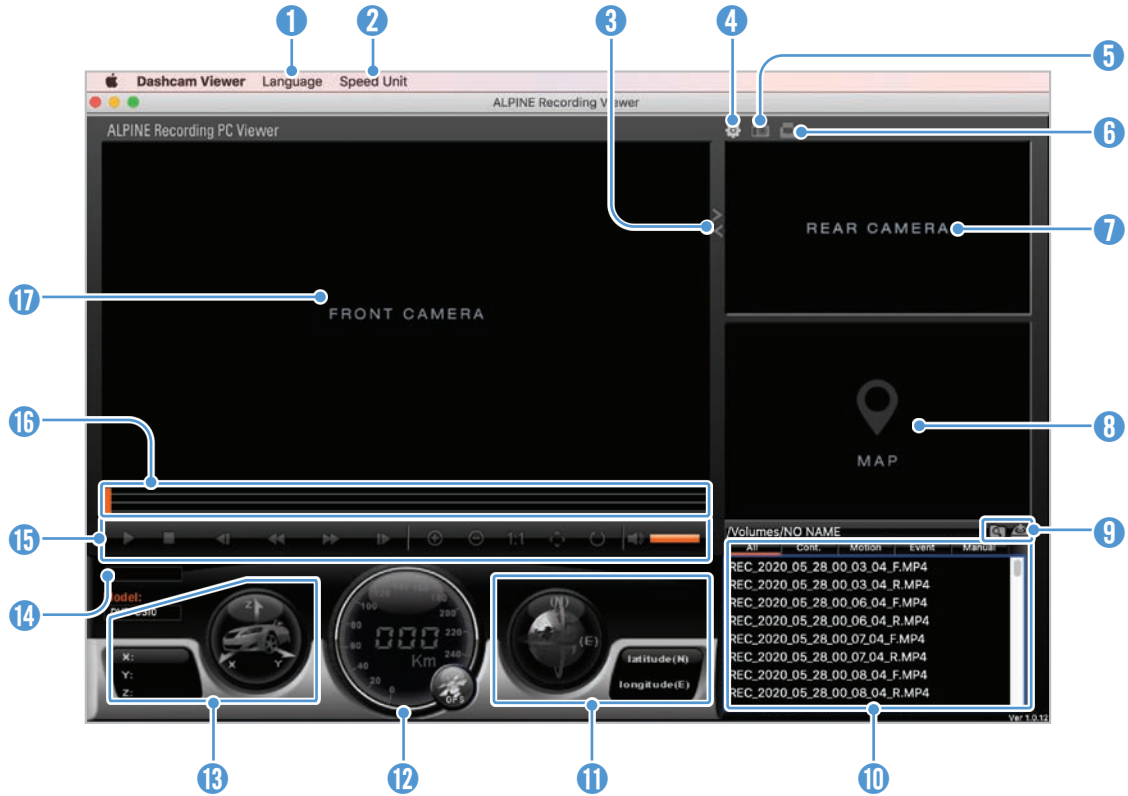

Number	Description
1	Set the language for the PC viewer.
2	Set the speed unit.
3	Switch between the front and rear videos.
4	View or configure the dash cam settings.
5	Save the current scene.
6	Print the current scene.
7	Displays the current rear video.
8	Displays the map screen.
9	Open a file, or save a video with a different name.
10	Displays the playlist.
11	Displays the GPS information at the time of recording.
12	Indicates the vehicle's driving speed at the time of recording.
13	Indicates the G sensor value at the time of recording.
14	Displays the current and total running time of the current video.
15	Play or control a video.
16	Displays the progress of video playback.
17	Displays the current front video. Right-click this pane to display the current video in full screen.

7.2.5 Playing recorded videos on the PC viewer (for Mac)

Follow the instructions to play recorded videos.

- 1 Turn off the product and remove the memory card.
- 2 Insert the memory card into your Mac using a SD card reader or SD card adapter provided.
- 3 Open the PC viewer.
- 4 Click  and locate the memory card.

The video files in the memory card will be automatically added to the playlist in the bottom-right corner of the PC viewer screen. The playlist section layout is as follows.

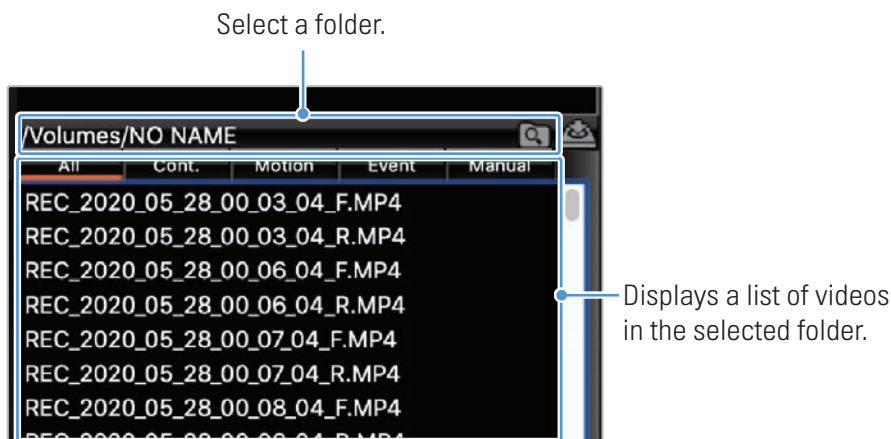

- 5 Double-click a video file after selecting a video folder, or click the Play (▶) button after selecting a video file. The selected video file will be played.

8. Upgrading the firmware

A firmware upgrade is provided to enhance the product's features, operation or to increase stability. For optimal operation of the product, ensure that you keep the firmware up to date.

Follow the instructions to upgrade the firmware.

- 1 On your PC, open a web browser and go to the Alpine website.
- 2 Select the product and download the latest firmware upgrade file.
- 3 Unzip the downloaded file.
- 4 Disconnect power to the product and remove the memory card.
- 5 Open the memory card on a PC and copy the firmware upgrade file to the root folder of the memory card.
- 6 While the power is disconnected from the product, insert the memory card into the memory card slot on the product.
- 7 Connect the power cable to the product, and then turn on the power (ACC ON) or start the engine to turn on the product. The firmware upgrade starts automatically, and the system will restart once the firmware update is completed.



Do not disconnect the power or remove the memory card from the product during the upgrade. Doing so may cause serious damage to the product, or to the data stored in the memory card.

9. Troubleshooting

The following table lists the problems users may encounter while using the product and measures to resolve them. If the problem persists after taking the measures provided in the table, contact the customer service center.

Problems	Solution
Cannot power on the product	<ul style="list-style-type: none">• Make sure the power cable (the hardwiring cable) is connected to the vehicle and the product properly.• Check the vehicle's battery level.
The voice guide and/or buzzer do not sound.	Check if the volume is set to the minimum.
The video is unclear or hardly visible.	<ul style="list-style-type: none">• Ensure that the protective film on the camera lens has been removed. The video may look unclear if the protective film is still on the camera lens.• Check the installation location of the front or rear camera, turn on the product, and then adjust the camera's viewing angle.
The memory card cannot be recognized.	<ul style="list-style-type: none">• Ensure that the memory card has been inserted in the correct direction. Before inserting the memory card, ensure that the metal contacts on the memory card are facing toward the lens of the product.• Turn off the power, remove the memory card, and then check to ensure that the contacts in the memory card slot are not damaged.• Ensure that the memory card is an authentic product distributed by Alpine. Alpine does not guarantee compatibility and normal operation of third-party memory cards.
The recorded video cannot be played on a PC.	The recorded videos are stored as MP4 video files. Ensure that the video player installed on your PC supports the playback of MP4 video files.
GPS signal cannot be received.	The GPS signal may not be received in out-of-service areas, or if the product is located between tall buildings. Also, GPS signal reception may not be available during storms or heavy rain. Try again on a clear day at a location that is known to have a good GPS reception. It may take up to 5 minutes until GPS reception is established.

Before contacting a service center

Please back up all important data stored in the memory card. The data in the memory card may be deleted during repair. Every product requested for repair is regarded as a device that has had its data backed up. The customer service center does not back up your data. Alpine is not responsible for any loss, such as data loss.

10. Specifications

To see the product specifications, refer to the following table.

Item	Specification	Remarks
Model name	DVR-C320R / DVR-C320S / RVC-C320	
Dimensions / Weight	92 x 73.3 x 36.8 mm / 166.6 g	Rear camera: 61.06 x 32.8 x 27.6 mm / 26 g
Memory	microSD card	16 GB, 32 GB, 64 GB, 128 GB (UHS-I)
Recording mode	Continuous Rec	Records videos in 1-minute segments (dual channels are supported for recording the front and rear view)
	Incident Rec	Records 10 seconds before and after the incident (total 20 seconds)
	Incident continuous Recording for BCWS	Records 10 seconds before and after rear and back collision danger is detected.
	Manual Rec	Records from 10 seconds before and 50 seconds after manually starting the recording (total 1 minute)
	Parking Rec (parking mode)	Motion Detection / Time Lapse / Energy Saving
Camera sensor	2.1 M Pixels, CMOS, 1080p	2.1 M Pixels, 1920x1080
Angle of view (Lens)	Large angle: 144° Horizontal: 112° Vertical: 59°	Rear camera: • Large angle: 160° • Horizontal: 112° • Vertical: 80°
Video	FHD (1920 x 1080 @ 30 fps / H.265 / MP4)	Rear camera: FHD (1920 x 1080 @ 30 fps / H.265 / MP4)
Audio	HE-AAC	Press the voice recording button to turn the audio recording on or off
Acceleration sensor	3-axis acceleration sensor (3D, ±3G)	
GPS	Embedded GPS	Supports ADAS features (LDWS, FCWS, Low Speed FCWS, BCW, FVDW).
Features	Format Free, High temperature shutdown, Battery depletion protection	
Wi-Fi	802.11 b/g/n 2.4G	
Power consumption	2ch: 4.9 W / 1ch: 3.9 W (mean)	Except for the fully charged supercapacitor / GPS
LED indicator	GPS, Wi-Fi, Security LED	
Alarm	Built-in speakers	Voice guide (buzzer sounds)
Operating temperature	14 – 140°F / -10 – 60°C	

For the approximate recording times of each memory partition setting, refer to the tables below.



- For more information about the memory partition settings, refer to "4.3 Managing the memory card" on page 28.
- For more information about the parking mode, refer to "3.5 Using parking mode" on page 22.

- Continuous Priority

Parking Mode	Card Size	Continuous Rec	Incident Rec	Manual Rec	Motion Detection (while parking)	Parking Incident
Motion Detection	16 GB	Approx. 94 min	Approx. 50 min	Approx. 13 min	Approx. 91 min	Approx. 38 min
	32 GB	Approx. 188 min	Approx. 100 min	Approx. 25 min	Approx. 181 min	Approx. 75 min
	64 GB	Approx. 376 min	Approx. 200 min	Approx. 50 min	Approx. 362 min	Approx. 150 min
	128 GB	Approx. 752 min	Approx. 400 min	Approx. 100 min	Approx. 724 min	Approx. 300 min
Timelapse	16 GB	Approx. 94 min	Approx. 50 min	Approx. 13 min	Approx. 23 min	Approx. 38 min
	32 GB	Approx. 188 min	Approx. 100 min	Approx. 25 min	Approx. 45 min	Approx. 75 min
	64 GB	Approx. 376 min	Approx. 200 min	Approx. 50 min	Approx. 90 min	Approx. 150 min
	128 GB	Approx. 752 min	Approx. 400 min	Approx. 100 min	Approx. 180 min	Approx. 300 min
Energy Saving	16 GB	Approx. 94 min	Approx. 50 min	Approx. 13 min	Approx. 91 min	Approx. 38 min
	32 GB	Approx. 188 min	Approx. 100 min	Approx. 25 min	Approx. 181 min	Approx. 75 min
	64 GB	Approx. 376 min	Approx. 200 min	Approx. 50 min	Approx. 362 min	Approx. 150 min
	128 GB	Approx. 752 min	Approx. 400 min	Approx. 100 min	Approx. 724 min	Approx. 300 min

- Incident Priority

Parking Mode	Card Size	Continuous Rec	Incident Rec	Manual Rec	Motion Detection (while parking)	Parking Incident
Motion Detection	16 GB	Approx. 68 min	Approx. 88 min	Approx. 13 min	Approx. 106 min	Approx. 87 min
	32 GB	Approx. 136 min	Approx. 176 min	Approx. 25 min	Approx. 211 min	Approx. 173 min
	64 GB	Approx. 272 min	Approx. 352 min	Approx. 50 min	Approx. 422 min	Approx. 346 min
	128 GB	Approx. 544 min	Approx. 704 min	Approx. 100 min	Approx. 844 min	Approx. 692 min
Timelapse	16 GB	Approx. 68 min	Approx. 88 min	Approx. 13 min	Approx. 26 min	Approx. 87 min
	32 GB	Approx. 136 min	Approx. 176 min	Approx. 25 min	Approx. 52 min	Approx. 173 min
	64 GB	Approx. 272 min	Approx. 352 min	Approx. 50 min	Approx. 104 min	Approx. 346 min
	128 GB	Approx. 544 min	Approx. 704 min	Approx. 100 min	Approx. 208 min	Approx. 692 min
Energy Saving	16 GB	Approx. 68 min	Approx. 88 min	Approx. 13 min	Approx. 106 min	Approx. 87 min
	32 GB	Approx. 136 min	Approx. 176 min	Approx. 25 min	Approx. 211 min	Approx. 173 min
	64 GB	Approx. 272 min	Approx. 352 min	Approx. 50 min	Approx. 422 min	Approx. 346 min
	128 GB	Approx. 544 min	Approx. 704 min	Approx. 100 min	Approx. 844 min	Approx. 692 min

Specifications

- Parking Priority

Parking Mode	Card Size	Continuous Rec	Incident Rec	Manual Rec	Motion Detection (while parking)	Parking Incident
Motion Detection	16 GB	Approx. 53 min	Approx. 42 min	Approx. 13 min	Approx. 314 min	Approx. 38 min
	32 GB	Approx. 105 min	Approx. 83 min	Approx. 25 min	Approx. 627 min	Approx. 75 min
	64 GB	Approx. 210 min	Approx. 166 min	Approx. 50 min	Approx. 1,254 min	Approx. 150 min
	128 GB	Approx. 420 min	Approx. 332 min	Approx. 100 min	Approx. 2,508 min	Approx. 300 min
Timelapse	16 GB	Approx. 53 min	Approx. 42 min	Approx. 13 min	Approx. 78 min	Approx. 38 min
	32 GB	Approx. 105 min	Approx. 83 min	Approx. 25 min	Approx. 156 min	Approx. 75 min
	64 GB	Approx. 210 min	Approx. 166 min	Approx. 50 min	Approx. 312 min	Approx. 150 min
	128 GB	Approx. 420 min	Approx. 332 min	Approx. 100 min	Approx. 624 min	Approx. 300 min
Energy Saving	16 GB	Approx. 53 min	Approx. 42 min	Approx. 13 min	Approx. 314 min	Approx. 38 min
	32 GB	Approx. 105 min	Approx. 83 min	Approx. 25 min	Approx. 627 min	Approx. 75 min
	64 GB	Approx. 210 min	Approx. 166 min	Approx. 50 min	Approx. 1,254 min	Approx. 150 min
	128 GB	Approx. 420 min	Approx. 332 min	Approx. 100 min	Approx. 2,508 min	Approx. 300 min

- Manual Priority

Parking Mode	Card Size	Continuous Rec	Incident Rec	Manual Rec	Motion Detection (while parking)	Parking Incident
Motion Detection	16 GB	Approx. 53 min	Approx. 63 min	Approx. 60 min	Approx. 38 min	Approx. 38 min
	32 GB	Approx. 105 min	Approx. 125 min	Approx. 120 min	Approx. 75 min	Approx. 75 min
	64 GB	Approx. 210 min	Approx. 250 min	Approx. 240 min	Approx. 150 min	Approx. 150 min
	128 GB	Approx. 420 min	Approx. 500 min	Approx. 480 min	Approx. 300 min	Approx. 300 min
Timelapse	16 GB	Approx. 53 min	Approx. 63 min	Approx. 60 min	Approx. 9 min	Approx. 38 min
	32 GB	Approx. 105 min	Approx. 125 min	Approx. 120 min	Approx. 18 min	Approx. 75 min
	64 GB	Approx. 210 min	Approx. 250 min	Approx. 240 min	Approx. 36 min	Approx. 150 min
	128 GB	Approx. 420 min	Approx. 500 min	Approx. 480 min	Approx. 72 min	Approx. 300 min
Energy Saving	16 GB	Approx. 53 min	Approx. 63 min	Approx. 60 min	Approx. 38 min	Approx. 38 min
	32 GB	Approx. 105 min	Approx. 125 min	Approx. 120 min	Approx. 75 min	Approx. 75 min
	64 GB	Approx. 210 min	Approx. 250 min	Approx. 240 min	Approx. 150 min	Approx. 150 min
	128 GB	Approx. 420 min	Approx. 500 min	Approx. 480 min	Approx. 300 min	Approx. 300 min

- Driving Recording Only

Parking Mode	Card Size	Continuous Rec	Incident Rec	Manual Rec	Motion Detection (while parking)	Parking Incident
Motion Detection	16 GB	Approx. 123 min	Approx. 42 min	Approx. 13 min	-	-
	32 GB	Approx. 246 min	Approx. 83 min	Approx. 25 min	-	-
	64 GB	Approx. 492 min	Approx. 166 min	Approx. 50 min	-	-
	128 GB	Approx. 984 min	Approx. 332 min	Approx. 100 min	-	-
Timelapse	16 GB	Approx. 123 min	Approx. 42 min	Approx. 13 min	-	-
	32 GB	Approx. 246 min	Approx. 83 min	Approx. 25 min	-	-
	64 GB	Approx. 492 min	Approx. 166 min	Approx. 50 min	-	-
	128 GB	Approx. 984 min	Approx. 332 min	Approx. 100 min	-	-
Energy Saving	16 GB	Approx. 123 min	Approx. 42 min	Approx. 13 min	-	-
	32 GB	Approx. 246 min	Approx. 83 min	Approx. 25 min	-	-
	64 GB	Approx. 492 min	Approx. 166 min	Approx. 50 min	-	-
	128 GB	Approx. 984 min	Approx. 332 min	Approx. 100 min	-	-



Hereby, Alpine Electronics (Europe) declares that the radio equipment type DVR-C320R and DVR-C320S are in compliance with Directive 2014/53/EU.

The full text of the EU declaration of conformity is available at the following internet address: <http://www.alpine.com/e/research/doc/>

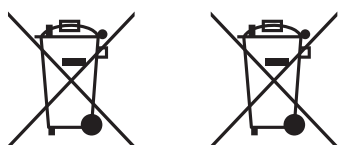

Information on Disposal of Old Electrical and Electronic Equipment and Battery (applicable for countries that have adopted separate waste collection systems)

If you want to dispose this product, do not mix it with general household waste. There is a separate collection system for used electronic products in accordance with legislation that requires proper treatment, recovery and recycling. Contact your local authority for details in locating a recycle facility nearest to you. Proper recycling and waste disposal will help conserve resources whilst preventing detrimental effects on our health and the environment.

WiFi (IEEE 802.11b/g/n) in the 2.4GHz ISM band (2412 ~ 2472MHz)

Maximum Power [17.47dBm / 55.9mW (EIRP)]

Rx only: GNSS(1563 ~ 1610MHz), GPS L1 (1575.42MHz) + GLONASS L1 (1602.00MHz)

Important information on the software

About the software licence of the product

The software installed in the product contains open-source software.

See the following Alpine website for details on the open source software.

www.alpine-usa.com

www.alpine-europe.com

www.alpine-usa.com
www.alpine-europe.com

Ver. 1.0 (Oct. 2020)

ALPINE ELECTRONICS OF AMERICA, INC.

1500 Atlantic Boulevard, Auburn Hills,
Michigan 48326, USA
Phone: 1-800-ALPINE-1 (1-800-257-4631)

ALPS ALPINE EUROPE GmbH

Ohmstrasse 4
85716 Unterschleissheim
Germany

For contact information on your respective country, please visit www.alpine-europe.com.